



Typical System Assembly

Standard 3/8" Glass Railing System

3-1/2" Round Glass Cap x 24' - GR106

with 1-1/2" deep glass pocket wall:0.125
52-63-10740 (FL)

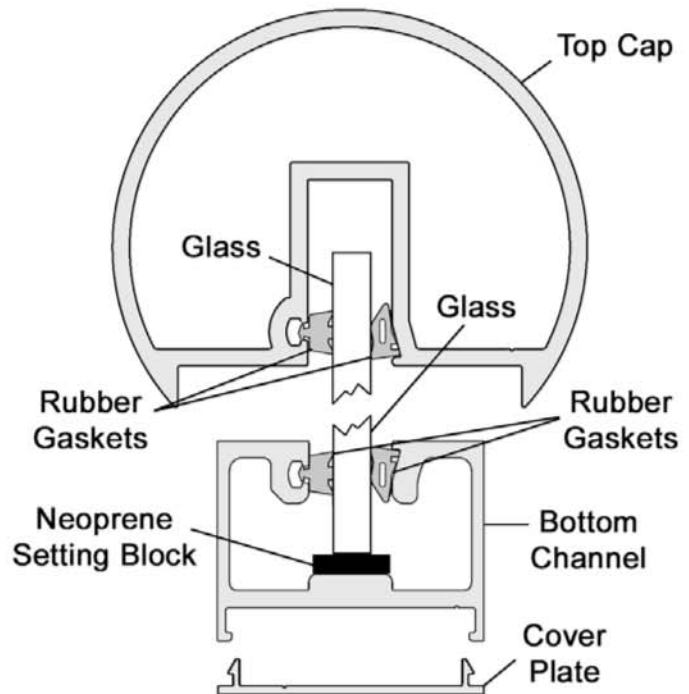
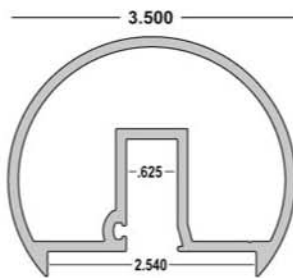

EMS does not stock rubber gaskets or neoprene setting blocks. Ask your sales rep for a recommended dealer.

2" x 1-1/2" Glass Bottom Channel x 24' GRC204

with 1" deep glass pocket wall:0.090 6063-T5
52-63-10741 (FL) Can be used as a Mid Rail when inverted

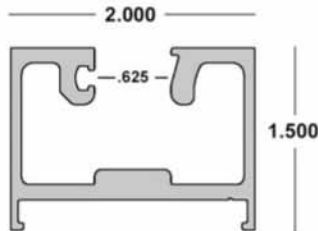

Cover Plate x 16' GRC214

mates with GRC200, GRC202, GRC204, GRC208, GRC210
52-63-11327 (FL) wall:0.090

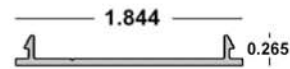

Glass Rail Inner Sleeve x 10' GRS110

Mates with GR106 wall:0.090
52-63-8915 (FL)

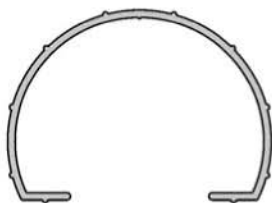

Glass Rail Post x 24'

2 x 2-1/2 x 1/8 Rect Tube 6061 T6
20-61-270 (FL)

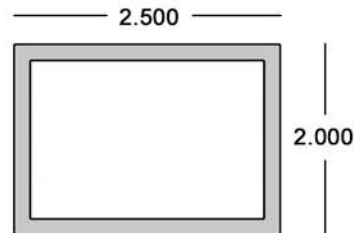

Handrailing 12



Eastern Metal Supply

Quality Shapes In Aluminum

EMS FL

1-800-432-2204
(561) 588-4780 - fax

EMS NC

1-800-343-8154
(704) 391-2267 - fax

EMS TX

1-800-996-6061
(281) 656-2297 - fax

EMS MO

1-888-822-6061
(314) 344-3349 - fax

Additional Locations: West Palm Beach & Lakeland, FL and Newark, DE

website: www.easternmetal.com

e-mail: info@easternmetal.com

version: 11/18/10

2-1/2" Round Glass Cap - GR100

with 1.070 deep glass pocket wall:0.125

Mill Order

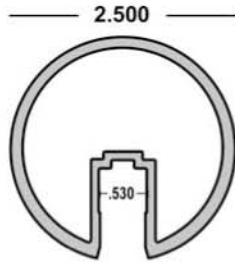

Accepts Castings:

Wall Mount: 21-00-302

End Cap: 21-00-135

2-1/2" Round Glass Cap - GR102

with 1.625 deep glass pocket wall:0.125

Mill Order

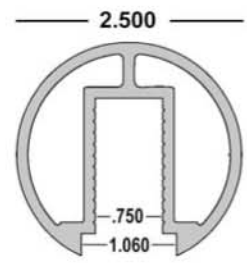

Accepts Castings:

Wall Mount: 21-00-302

End Cap: 21-00-135

3" Round Glass Cap - GR104

with 1.500 deep glass pocket wall:0.082

Mill Order

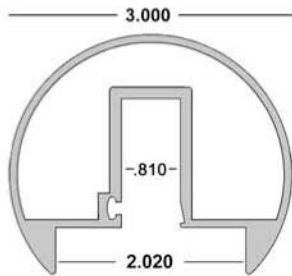

3-1/2" Round Glass Cap - GR108

with 1.750 deep glass pocket wall:0.125

Mates with GRS110 52-63-8915 (FL)

Mill Order

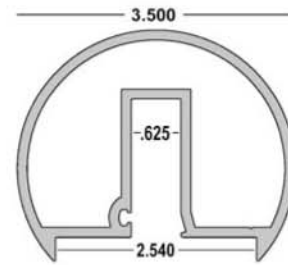

3-1/2" Heavy Round Glass Cap - GR112

with 1.875 deep glass pocket wall:0.125

Mill Order

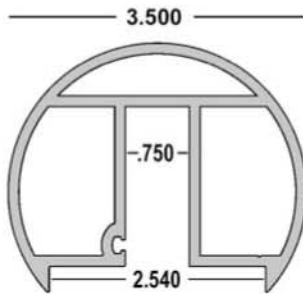

3-1/2" Round Glass Cap - GR114

with 1.250 deep glass pocket wall:0.120

Mill Order

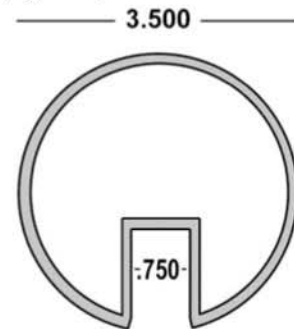

4" Round Glass Cap - GR116

with 1.250 deep glass pocket wall:0.125

Mill Order

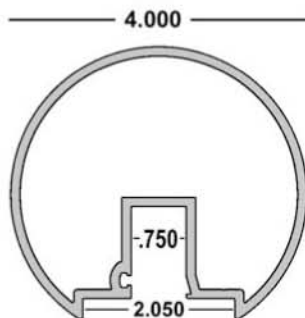

4-1/2" Round Top Cap - GR118

with 1.750 deep glass pocket wall:0.105

Mill Order

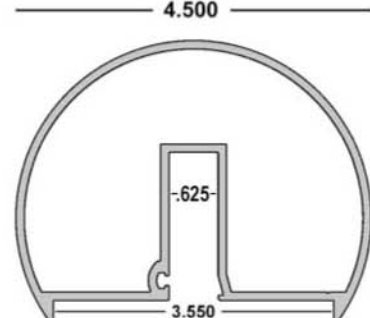

Handrailing 13



Eastern Metal Supply

Quality Shapes In Aluminum

EMS FL

1-800-432-2204

(561) 588-4780 - fax

EMS NC

1-800-343-8154

(704) 391-2267 - fax

EMS TX

1-800-996-6061

(281) 656-2297 - fax

EMS MO

1-888-822-6061

(314) 344-3349 - fax

Additional Locations: West Palm Beach & Lakeland, FL and Newark, DE

website: www.easternmetal.com

e-mail: info@easternmetal.com

version: 01/28/11

4-1/2" Inner Sleeve - GR120

Mates with GR118 wall:0.080
 Mill Order

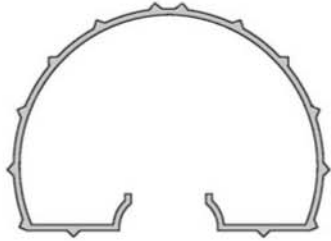
**3-1/2" x 2-1/2" Rect Glass Top Cap - GR122**

with 1.680 deep glass pocket wall:0.125
 Mill Order

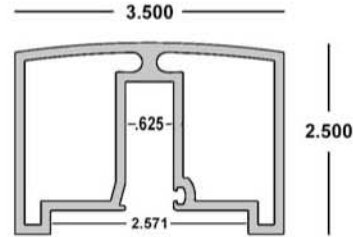
**Inner Sleeve for 3-1/2" x 2-1/2" Rect Glass Top Cap - GR124**

Mates with GR122 wall:0.080
 Mill Order

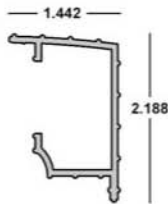
**4-1/2" Offset Oval Glass Cap - GR300**

with 1.75 deep glass channel
 Mill Order wall:0.110

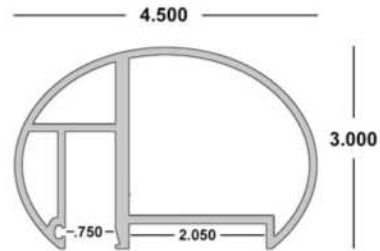
**6" x 2-1/4" Offset Oval Glass Rail Cap GR302**

with 2.00 deep glass channel
 Mill Order wall:0.090 Mates with 312

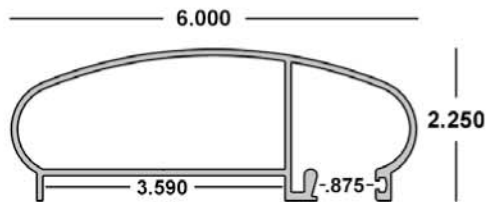
**6-1/2" x 3-3/4" Offset Oval Glass Rail Cap - GR304**

with 2.00 deep glass channel
 Mill Order wall:0.150 Mates with 312

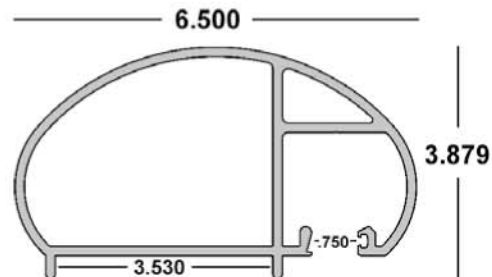
**3-1/2" x 2-1/2" Offset Bottom Channel GR310**

with 1.75 deep glass channel
 Mill Order wall:0.090

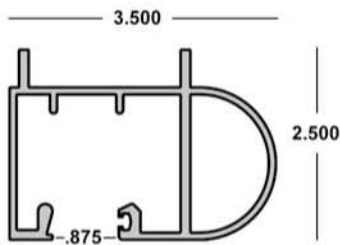
**3.5" x 2" Heavy Duty Glass Rail Post GR312**

receives 3/8" x 3" flat bar; Mates with GRC302 & GRC304
 Mill Order wall:0.094

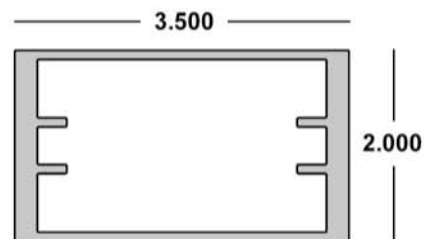

Handrailing 14



Eastern Metal Supply

Quality Shapes In Aluminum

EMS FL

1-800-432-2204
 (561) 588-4780 - fax

EMS NC

1-800-343-8154
 (704) 391-2267 - fax

EMS TX

1-800-996-6061
 (281) 656-2297 - fax

EMS MO

1-888-822-6061
 (314) 344-3349 - fax

Additional Locations: West Palm Beach & Lakeland, FL and Newark, DE

website: www.easternmetal.com

e-mail: info@easternmetal.com

version: 10/25/10

2" x 1-1/4" Glass Bottom Channel - GRC200

with 0.750 deep glass pocket
 Mill Order wall:0.125

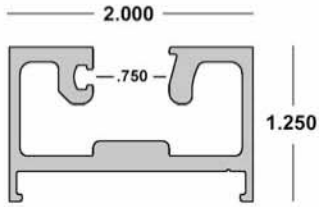

2" x 1-1/2" Glass Bottom Channel - GRC202

with 0.687 deep glass pocket
 Mill Order wall:0.090

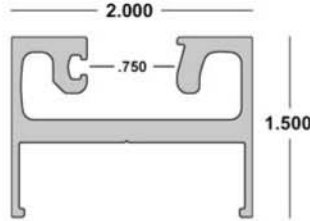

2" x 1-1/2" Glass Bottom Channel x 24' - GRC204

with 1.000 deep glass pocket
 52-63-10741 (FL) wall:0.090
 6063-T52

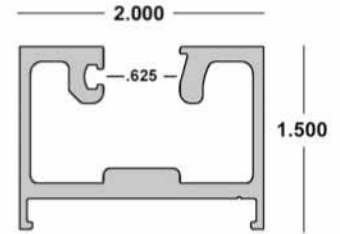

2" x 1-5/8" Glass Bottom Channel - GRC206

with 0.875 deep glass pocket
 Mill Order wall:0.125

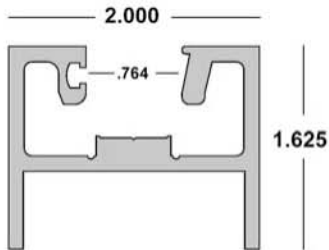

2" x 1-3/4" Glass Bottom Channel - GRC208

with 0.750 deep glass pocket
 Mill Order wall:0.120

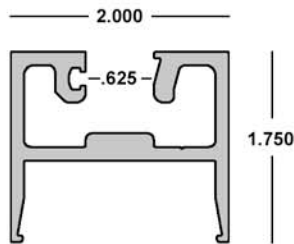

2" x 1-1/2" Mid Rail Glass Channel - GRC210

with 1.250 deep glass pocket
 Mill Order wall:0.090

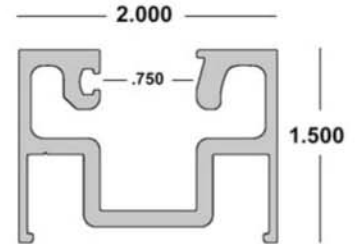

2" x 1-5/8" Mid Rail Glass Channel - GRC212

with 1.500 deep glass pocket
 Mill Order wall:0.125

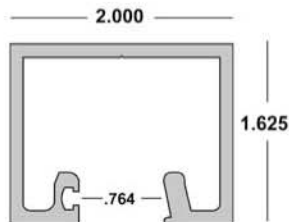

2-1/4" x 2" Glass Channel GRC213

with 1.500 deep glass pocket
 Mill Order wall:0.125

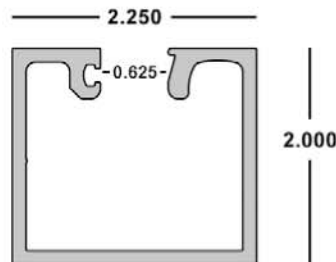

Cover Plate - GRC214

mates with GRC200, GRC202, GRC204, GRC208, GRC210
 Mill Order wall:0.090

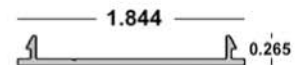

Handrailing 15



Eastern Metal Supply

Quality Shapes In Aluminum

EMS FL

1-800-432-2204
 (561) 588-4780 - fax

EMS NC

1-800-343-8154
 (704) 391-2267 - fax

EMS TX

1-800-996-6061
 (281) 656-2297 - fax

EMS MO

1-888-822-6061
 (314) 344-3349 - fax

Additional Locations: West Palm Beach & Lakeland, FL and Newark, DE

website: www.easternmetal.com

e-mail: info@easternmetal.com

version: 04/28/10

2-1/2" x 4" Glass Shoe Base

with 3.125 deep glass pocket
 51-63-325 (TX) wall:0.000

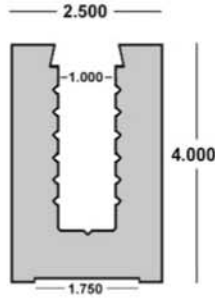
**2-1/2" x 3-1/2" Glass Shoe Base**

with 2.938 deep glass pocket
 Mill Order wall:0.000

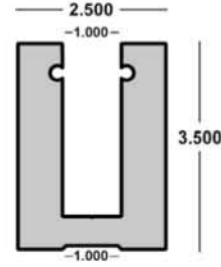
**2-1/4" x 3" Glass Shoe Base**

with 2.063 deep glass pocket
 Mill Order wall:0.625

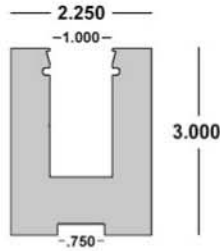
**1-1/4" x 1-1/4" Offset Glass Channel**

GR308 with 1.00 deep glass channel
 Mill Order wall:0.250

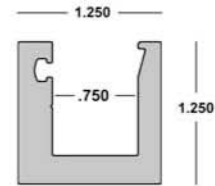
**2" x 1-1/4" Offset Glass Channel**

GR306 with 1.75 deep glass channel
 Mill Order/New Die Required wall:0.250

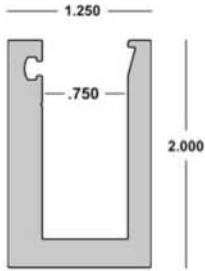

Handrailing 16



Eastern Metal Supply

Quality Shapes In Aluminum

EMS FL

1-800-432-2204
 (561) 588-4780 - fax

EMS NC

1-800-343-8154
 (704) 391-2267 - fax

EMS TX

1-800-996-6061
 (281) 656-2297 - fax

EMS MO

1-888-822-6061
 (314) 344-3349 - fax

Additional Locations: West Palm Beach & Lakeland, FL and Newark, DE

website: www.easternmetal.com

e-mail: info@easternmetal.com

version: 04/28/10