

# ROLL SHUTTER COMPONENTS

## GEAR 1/11 RATIO 7MM HEX - 1 each

6A23811PF7 66 LBS. MAX  
 6A23811ZF7 66 LBS. MAX ZAMAC  
 2002146 1424 SIMU GEAR 11/1  
 2002392 GEAR CONNECTOR  
 (mates with 2002146)

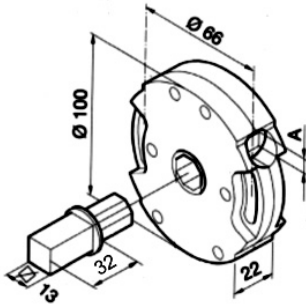

Comes with Hexagonal Pivot & Clip

## GEAR 1/8 RATIO 7MM HEX - 1 each

6A23808PF7 44 LBS. MAX  
 6A23808ZF7 44 LBS. MAX ZAMAC

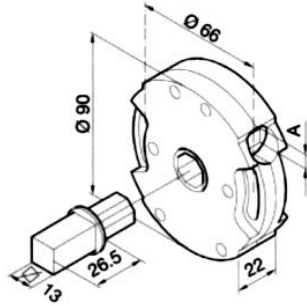

Comes with Hexagonal Pivot & Clip

## 5' CRANK HANDLE W/BELL - 1 each

6A322E78215 (NICKEL)



## 90 DEG UNIVERSAL HEX DRIVE

6A323S584E7 2 HOLE  
 1 each

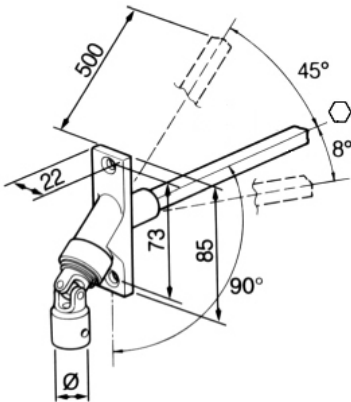

Bullet Sold Separately/bag of 20 - 6A32341FX

## 90 DEG UNIVERSAL HEX DRIVE

6A323T584E7 4 HOLE  
 1 each

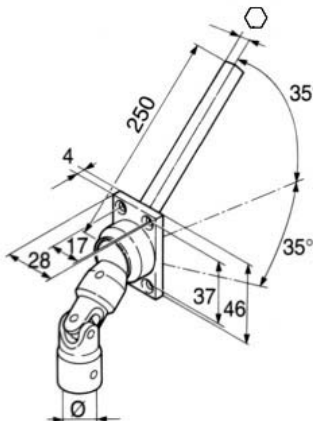

Bullet Sold Separately/bag of 20 - 6A32341FX

## ASSIST SPRING - 1 each

6C0445160G2 60 mm 75 lb (34 KG)  
 7014-023 60 mm 137 lb (62KG)

6C0450140G4 70 mm 123 lb (60 KG)  
 2005355 70 mm 220 lb (100 KG)

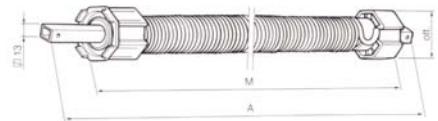

## 60 MM NYLON IDLE SIDE

ADJ CAP W/PIVOT - METAL  
 6C66643AL 1 each  
 ADJ CAP W/PIVOT/PLASTIC  
 6C66643 1 each

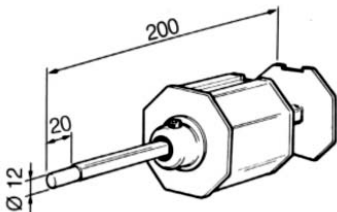

## 70 MM NYLON IDLE SIDE

ADJ PIVOT/METAL  
 6C66645AL 1 each  
 ADJ PIVOT/PLASTIC  
 6C66645 1 each

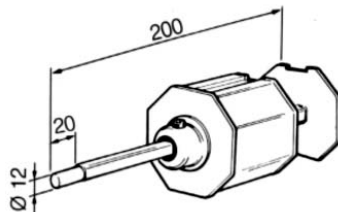

## CAP WITH SQUARE HOLE

60MM NYLON GEAR INSERT  
 6D66603 1 EACH  
 60MM ALUM GEAR INSERT  
 6C66603AL 1 EACH  
 MATES WITH HEXAGONAL  
 PIVOT/GEAR

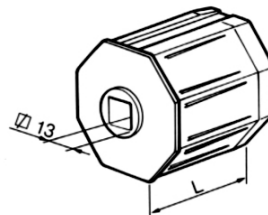

## CAP WITH SQUARE HOLE

70MM ALUM GEAR INSERT  
 6C66605AL 1 each  
 MATES WITH HEXAGONAL  
 PIVOT/GEAR

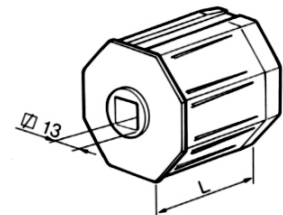

Hurricane 22



**Eastern Metal Supply**  
 Quality Shapes In Aluminum

[EMS FL](#)  
 1-800-432-2204  
 (561) 588-4780 - fax

[EMS NC](#)  
 1-800-343-8154  
 (704) 391-2267 - fax

[EMS TX](#)  
 1-800-996-6061  
 (281) 656-2297 - fax

[EMS MO](#)  
 1-888-822-6061  
 (314) 344-3349 - fax

**Additional Locations:** West Palm Beach & Lakeland, FL and Newark, DE

[website: www.easternmetal.com](http://www.easternmetal.com)

[e-mail: info@easternmetal.com](mailto:info@easternmetal.com)

[version: 04/28/10](#)

# ROLL SHUTTER COMPONENTS

## BEARING END CAP

(bearing not included)  
 2003504 60MM  
 2003505 70MM

## ADAPTER RING

2006280 60 MM  
 2003501 70 MM

## STAINLESS STEEL ROLL SHUTTER BEARING

41-HV-SB100 END  
 41-HV-SB101 CENTER



## 42 MM BALL BEARING STEEL - 1 each

6C35802 BUSHING

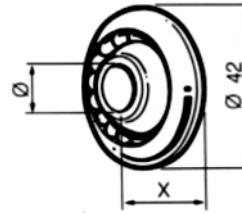

## BEARING PLATE - 1 each

6A39431  
 comes with 4 mounting screws

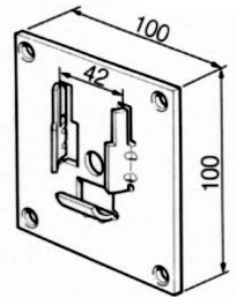

## HEAVY DUTY BEARING PLATE - 1 each

7006107

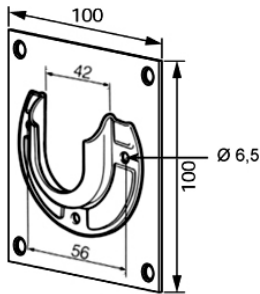

## PLATE FOR GEAR

1 each  
 6A39436  
 comes with 4 mounting screws

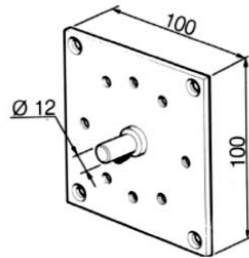

## UNIVERSAL PLATE FOR GEAR - 1 each

6A39441 NO PIN  
 2003639 100 MM SIMU  
 GEAR PLATE

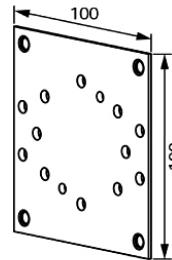

## SPRING SUPPORT PLATE

1 each  
 6A39438  
 comes with 1 screw and 1 nut

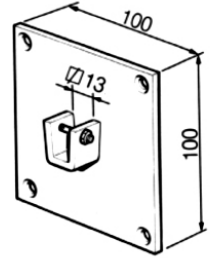

## 5/8" TRACK PLUGS

500 each  
 58NPWH WHITE  
 58NPV IVORY  
 58NPBG BEIGE  
 58NPMB BRONZE



## 10 MM TRACK PLUGS

1000 each  
 701277 WHITE

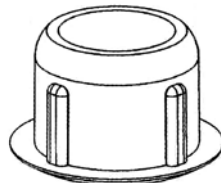

## CONICAL STOP - 1 each

6D3332320 WHITE  
 2006136 IVORY  
 2006320 BEIGE  
 2003493 BRONZE

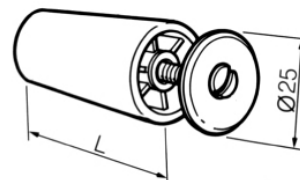

Comes with End Cap Screw

## ENTRY GUIDE - 1 set

(as a set - left & right)  
 WHITE  
 6D8642020  
 for 40mm slat  
 2005490  
 for 55mm & 60mm slat

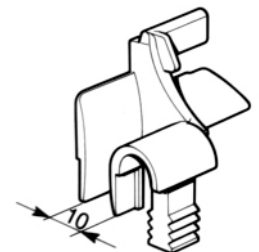

Mates with all available end caps

Hurricane 23



**Eastern Metal Supply**  
 Quality Shapes In Aluminum

**EMS FL**  
 1-800-432-2204  
 (561) 588-4780 - fax

**EMS NC**  
 1-800-343-8154  
 (704) 391-2267 - fax

**EMS TX**  
 1-800-996-6061  
 (281) 656-2297 - fax

**EMS MO**  
 1-888-822-6061  
 (314) 344-3349 - fax

**Additional Locations:** West Palm Beach & Lakeland, FL and Newark, DE

**website:** [www.easternmetal.com](http://www.easternmetal.com)

**e-mail:** [info@easternmetal.com](mailto:info@easternmetal.com)

**version:** 10/24/11

# ROLL SHUTTER COMPONENTS

## 45 DEGREE END CAP

2006315 MILL FINISH  
5" 125MM 1 pair  
2005327 MILL FINISH  
6-1/2" 165MM 1 pair

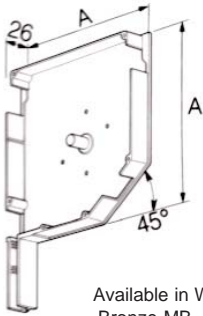

Available in White-W,  
Bronze-MB, Ivory-IV,  
and Beige-BG  
Mill Finish (special order)

## 45 DEGREE END CAP

6C81518M20(COLOR)  
7" 180MM 1 pair  
6C81520M20(COLOR)  
8" 205MM 1 pair

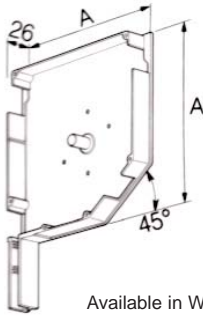

Available in White-W,  
Bronze-MB, Ivory-IV,  
and Beige-BG  
Mill Finish (special order)

## 45 DEGREE 8" END CAP

7008-592(COLOR)  
8" 205MM LARGE LEG 1 pair

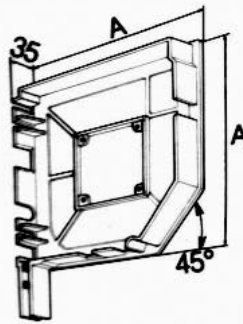

Available in White-W,  
Bronze-MB, Ivory-IV,  
and Beige-BG  
Mill Finish (special order)

## 45 DEGREE 10" END CAP

6C8172520(COLOR)  
10" 250 MM 1 pair

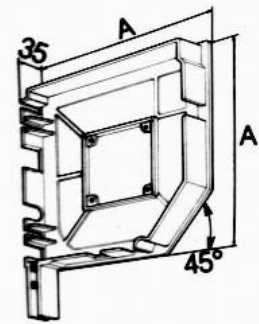

Available in White-W,  
Bronze-MB, Ivory-IV,  
and Beige-BG  
Mill Finish (special order)

## 45 DEGREE 12" END CAP

6C8173020(COLOR)  
12" 300 MM 1 pair

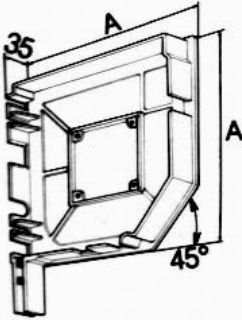

Available in White-W,  
Bronze-MB, Ivory-IV,  
and Beige-BG  
Mill Finish (special order)

## 90 DEGREE END CAP

SMALL LEG MILL FINISH  
2002721 7"  
2002731 8"  
2002741 10"

## SLAT HANGER - 1 each

6A33619FX  
for 55mm, 58mm, 60mm slats  
6A33713FX  
for 40mm slats

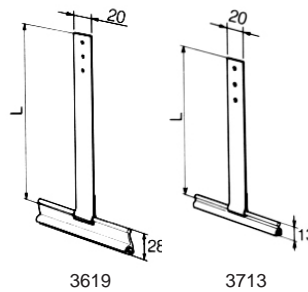

## SAFETY PLATE - 1 pair

7008-549 HOLE 72  
FOR 7" END CAP  
7008-551 HOLE 72  
FOR 8" END CAP  
7008-457 HOLE 92  
FOR 8" END CAP  
7008-245 HOLE 92  
FOR 10" END CAP  
7008-247 HOLE 92  
FOR 12" END CAP

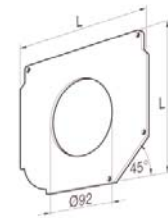

## DOUBLE ADJUSTABLE

6A66743 CAP-60MM  
**DOUBLE ADJUSTABLE**  
6A66745 CAP-70 MM  
Plastic/1 each

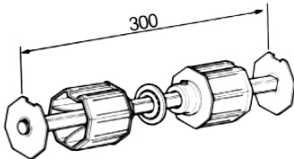

## ADJ ARTICULATED CAP-

60MM 6A66753  
PLASTIC  
1 pcs/box

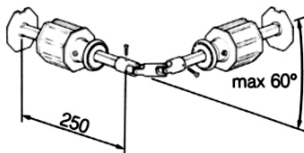

## CAP W/ROUND PIVOT

60MM  
6D66633 PLASTIC  
1 pcs/box

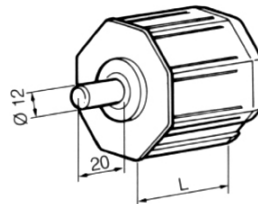

## CAP W/ROUND PIVOT

60MM  
6D66633AL ALUMINUM  
**CAP W/ROUND PIVOT**  
70MM  
6D66635AL ALUMINUM  
1 pcs/box

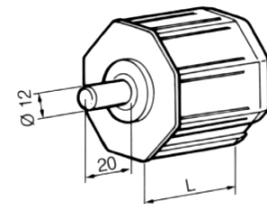

Hurricane 24



**Eastern Metal Supply**  
Quality Shapes In Aluminum

[EMS FL](#)

1-800-432-2204  
(561) 588-4780 - fax

[EMS NC](#)

1-800-343-8154  
(704) 391-2267 - fax

[EMS TX](#)

1-800-996-6061  
(281) 656-2297 - fax

[EMS MO](#)

1-888-822-6061  
(314) 344-3349 - fax

**Additional Locations:** West Palm Beach & Lakeland, FL and Newark, DE

[website: www.easternmetal.com](http://www.easternmetal.com)

[e-mail: info@easternmetal.com](mailto:info@easternmetal.com)

[version: 12/17/10](#)

## Standard Motors

### Type 5

#### Type 5 - SIMU Standard Motors

T5 30 Nm 12 rpm 120 V (530)	2000651
T5 40 Nm 12 rpm 120 V (540)	2000652
T5 50 Nm 12 rpm 120 V (550)	2000653

#### Type 5 - Override Motors - (Standard)

DMI5 30 Nm 12 rpm 120 V (MO 530)	2000774
DMI5 40 Nm 12 rpm 120 V (MO 540)	2000775
DMI5 50 Nm 12 rpm 120 V (MO 550)	2000776

#### Type 5 - Operator Adaptors - (Standard)

T5 60mm octagonal set, aluminum drive wheel	9012814
T5 70mm octagonal set, aluminum drive wheel	9012812

#### Type 5 - Operator Brackets - (Standard)

T5 operator bracket 80mm x 80mm square	9520049
T5 operator bracket 100mm x 100mm square	9520187

### Type 6

#### Type 6 - SIMU Standard Motors

T6 80 Nm 14 rpm 120 V (680)	2000986
T6 100 Nm 14 rpm 120 V (6100)	2000987

#### Type 6 - Override Motors - (Standard)

DMI6 80 Nm 14 rpm (MO 680)	2001042
DMI6 100 Nm 14 rpm 120 V (MO 6100)	2001044

#### Type 6 - Operator Adaptors - (Standard)

T6 70mm octagonal set, aluminum drive wheel	9012815
---	---------

#### Type 6 - Operator Brackets - (Standard)

T6 operator bracket 100mm x 100mm square	9530018
--	---------

### Type 8

#### Type 8 - SIMU Standard Motors

T8 200 Nm 94mm diameter 10 rpm 120 V	2004248
--------------------------------------	---------

#### Type 8 - Override Motors - (Standard)

T8 200 Nm 94mm diameter 10 rpm 120 V	2004249
--------------------------------------	---------

#### Type 8 - Operator Adaptors - (Standard)

T8 94MM round drive wheel	9001297
---------------------------	---------

#### Type 8 - Operator Brackets - (Standard)

T8 bracket angle 2 piece set	9001413
------------------------------	---------

#### Type 8 - Operator Accessories - (Standard)

T8-9 override eye & shaft	9340020
T8 idler support	2003807
94mm idle insert	9542008

#### Standard Toggle switches

Toggle switch single pole maintained (ivory)	2005520
Toggle switch single pole maintained (white)	2005521
Toggle switch single pole momentary (ivory)	2005522
Toggle switch single pole momentary (white)	2005523

#### Standard Designer Switches

Designer Switch single pole maintained (ivory)	2005553
Designer Switch single pole maintained (white)	2005554
Designer Switch single pole momentary (ivory)	2005558
Designer Switch single pole momentary (white)	2005559

#### Standard Key Switches

Maintain Key Switch	2001547
Momentary Key Switch	2001548

#### Standard Test Switch

Installation Test switch	2001476
--------------------------	---------

Hurricane 25



[EMS FL](#)

1-800-432-2204  
(561) 588-4780 - fax

[EMS NC](#)

1-800-343-8154  
(704) 391-2267 - fax

[EMS TX](#)

1-800-996-6061  
(281) 656-2297 - fax

[EMS MO](#)

1-888-822-6061  
(314) 344-3349 - fax

**Eastern Metal Supply**

Quality Shapes In Aluminum

**Additional Locations:** West Palm Beach & Lakeland, FL and Newark, DE

**website:** [www.easternmetal.com](http://www.easternmetal.com)

**e-mail:** [info@easternmetal.com](mailto:info@easternmetal.com)

**version:** 10/25/10

## Radio Motors (remote control)

### Type 5

#### Type 5 - SIMU Radio Hertz Motors (Remote Control)

T5Hz 20 Nm 12 rpm 120 V (Hz 520)	2006353
T5Hz 30 Nm 12 rpm 120 V (Hz 530)	2005136
T5Hz 50 Nm 12 rpm 120 V (Hz 550)	2005137

#### Type 5 - Override Motors - (radio Hertz/remote control)

DMI5Hz 30 Nm 12 rpm 120 V (MO Hz 530)	2004673
DMI5Hz 50 Nm 12 rpm 120 V (MO Hz 550)	2004675

#### Type 5 - Operator Adaptors (radio Hertz/remote control)

T5 60mm octagonal set, aluminum drive wheel	9012814
T5 70mm octagonal set, aluminum drive wheel	9012812

#### Type 5 - Operator Brackets (radio Hertz/remote control)

T5 operator bracket 80mm x 80mm square	9520049
T5 operator bracket 100mm x 100mm square	9520187

### Type 6

#### Type 6 - SIMU Radio Hertz Motors (Remote Control)

T6Hz 80 Nm 14 rpm 120 V (Hz 680)	2006061
T6Hz 100 Nm 14 rpm 120 V (Hz 6100)	2006062

#### Type 6 - Override Motors - (radio Hertz/remote control)

DMI6Hz 80 Nm 14 rpm 120V (MO Hz 680)	2006057
DMI6Hz 100 Nm 14 rpm 120 V (MO Hz 6100)	2006058

#### Type 6 - Operator Adaptors - (radio Hertz/remote control)

T6 70mm octagonal set, aluminum drive wheel	9012815
---	---------

#### Type 6 - Operator Brackets - (radio Hertz/remote control)

T6 operator bracket 100mm x 100mm square	9530018
--	---------

## Remote switches

### Hz Radio Systems Accessories-remote controls

#### Hz transmitters

1 channel handheld (white)	2006138
5 channel handheld (white)	2006143
1 channel recessed designer (white)	1810603
1 channel recessed designer (ivory)	1810604
5 channel recesses designer (white)	1810605
5 channel recesses designer (ivory)	1810606
5 channel recesses designer (ivory)	1810606

Digital security key switch	2006029
Hz 2 channel key FOB	2005326
Hz 4 channel key FOB	2005914

## DISCOUNT MOTORS

### Type 5

Type 5 Hybrid Motor-550 over-ride (includes 60mm and 70mm adapters-drives and 100mm motor bracket)	2802222
ASA brand-550 over-ride (adapters sold separately)	2249054

ASA operator adaptor 60mm	2204006
ASA operator adaptor 70mm	2200004
ASA operator bracket	2200043

### Type 6

2253072 - 6100 Override Hybrid
2200043 - 100 x 100 motor mounting plate (Option if needed)

2200004 70mm octagonal adaptor set
2204006 60mm octagonal adaptor set

## Also Available: Roll Shutter Hoods

*Ask your sales representative  
for more information*



Hurricane 26



**Eastern Metal Supply**  
Quality Shapes In Aluminum

EMS FL

1-800-432-2204  
(561) 588-4780 - fax

EMS NC

1-800-343-8154  
(704) 391-2267 - fax

EMS TX

1-800-996-6061  
(281) 656-2297 - fax

EMS MO

1-888-822-6061  
(314) 344-3349 - fax

**Additional Locations:** West Palm Beach & Lakeland, FL and Newark, DE

**website:** [www.easternmetal.com](http://www.easternmetal.com)

**e-mail:** [info@easternmetal.com](mailto:info@easternmetal.com)

**version:** 06/27/11