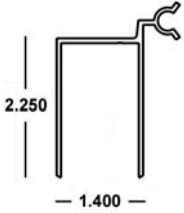
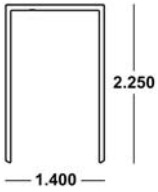
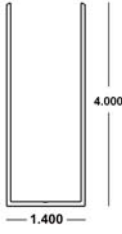
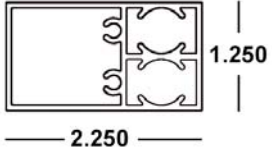
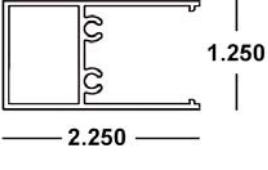
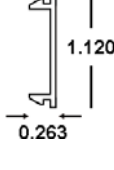
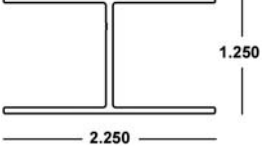
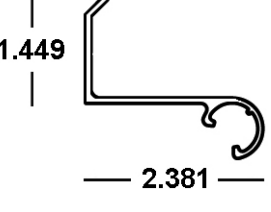
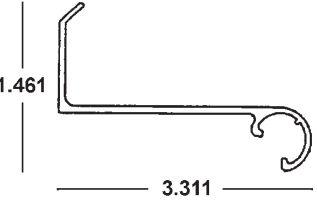
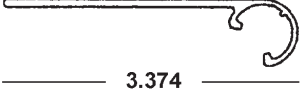
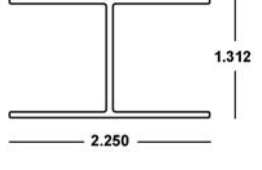
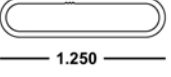
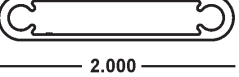
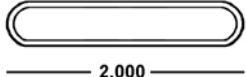
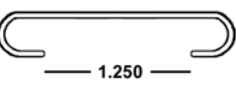
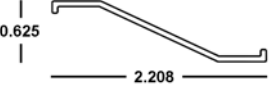
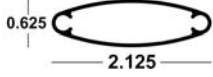

# Eastern Metal Supply

**NEW FOR  
MARCH 2009!**

## HV Low Profile **Decorative** Bahama Colonial System

|  |   |  |  |
|--|---|--|--|
| <p>HV LOW PROFILE MALE BAHAMA FRAME w/HINGE x 12'<br/>41-63-837 Mill Finish</p>   | <p>HV LOW PROFILE TOP &amp; BOTTOM FRAME x 12'<br/>41-63-833 Mill Finish</p> <p><i>Colonial may use as an intermediate rail</i></p>          | <p>HV LOW PROFILE 4" NEW ORLEANS STYLE BOTTOM RAIL<br/>Mill Order Mill Finish</p>   |  |
| <p>HV LOW PROFILE SIDE FRAME x 21'<br/><b>PUNCHED for 1-1/4" Blades</b><br/>41-63-832L125 Left MF<br/>41-63-832R125 Right MF<br/><b>PUNCHED for 2" Blades</b><br/>41-63-832L200 Left MF<br/>41-63-832R200 Right MF</p>  | <p>HV LOW PROFILE VERTICAL FRAME WITH SNAP x 16' 2"<br/><b>for Z-Blade System</b><br/>Mates with 41-63-861R/L<br/>41-63-860 Mill Finish</p>  | <p>HV LOW PROFILE Z - SNAP PLATE x 16' 2"<br/><b>for Z-Blade System</b><br/>Mates with 41-63-860<br/>Punched to accept Z-Blade<br/>41-63-861R Right MF<br/>41-63-861L Left MF</p>  | <p>HV LOW PROFILE BAHAMA VERTICAL CENTER MULLION x 21'<br/>Punched to accept blades<br/>41-63-838P125 (1-1/4" blade)<br/>41-63-838P200 (2" blade)<br/>41-63-862 (Z-blade) x 16' 2"<br/>Mill Finish Bahama Applications</p>  |
| <p>HV LOW PROFILE BAHAMA FEMALE AWNING HINGE x 20'<br/>41-63-803 Mill Finish</p>   | <p>HV LOW PROFILE 1" BUILD-OUT BAHAMA FEMALE HINGE x 20'<br/>41-63-804 Mill Finish</p>   | <p>BAHAMA FEMALE FLAT HINGE x 20'<br/>41-63-805 Mill Finish<br/>6 pcs For Ceiling Mounts</p>   | <p>HV LOW PROFILE COLONIAL HORIZONTAL RAIL x 16' 2"<br/>41-63-863 Mill Finish Colonial Applications</p>   |
| <p>1.25 HV LOW PROFILE BLADE x 12'<br/>41-63-834 Mill Finish</p>    | <p>BAHAMA/COLONIAL HOLLOW BLADE x 16'<br/>80-MF-013 Mill Finish Uses #14 screw</p>   | <p>BAHAMA DECORATIVE BLADE x 16'<br/>41-63-830 (Non-Impact) Mill Finish</p>   |  |
| <p>COLONIAL DECORATIVE BLADE x 16'<br/>41-63-835 (Non-Impact) Mill Finish</p>   | <p>HV LOW PROFILE Z-BLADE x 12' 2"<br/>52-63-060 Mill Finish <b>for Z-Blade System</b></p>   | <p>2-1/8" BAHAMA/COLONIAL HOLLOW AIR FOIL BLADE*<br/>Mill Order*Special Mill Order Frame Required</p>   |  |

**\*Currently available for decorative applications; Future code testing pending**

**Note: For applications requiring code rated hurricane protection refer to EMS High Visibility Bahama/Colonial product.**



**Eastern Metal Supply**  
Quality Shapes In Aluminum

EMS FL

1-800-432-2204

(561) 588-4780 - fax

EMS NC

1-800-343-8154

(704) 391-2267 - fax

EMS TX

1-800-996-6061

(281) 656-2297 - fax

EMS MO

1-888-822-6061

(314) 344-3349 - fax

**Additional Locations:** West Palm Beach & Lakeland, FL and Newark, DE

**website:** [www.easternmetal.com](http://www.easternmetal.com)









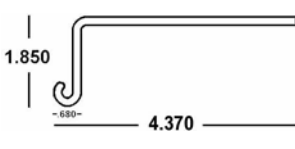

**e-mail:** [info@easternmetal.com](mailto:info@easternmetal.com)

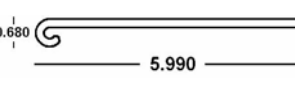
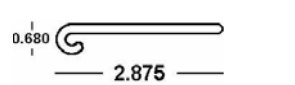
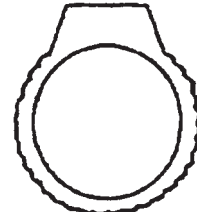
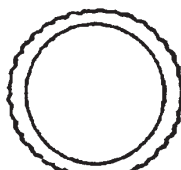
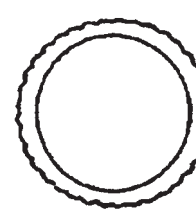
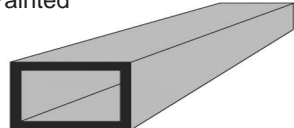
Low\_Profile-10/02/09

# Eastern Metal Supply

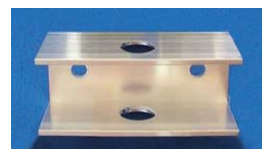
**NEW FOR  
MARCH 2009!**

## HV Low Profile **Decorative** Bahama Colonial System

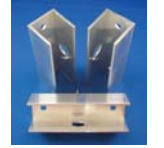
|   |   |   |   |
|---|---|---|---|
| <p>COLONIAL SINGLE HINGE<br/>x 12' Mill Finish 6 pcs<br/>41-63-816 Wall Mount<br/>Mates with 41-63-824N</p>                                   | <p>COLONIAL DOUBLE HINGE<br/>x 12' Mill Finish 4 pcs<br/>41-63-813 Wall Mount<br/>Mates with 41-63-824N</p>                            | <p>COLONIAL FLAT HINGE<br/>x 12' Mill Finish 6 pcs<br/>41-63-811 Wall Mount<br/>Mates with 41-63-824N</p>   | <p>COLONIAL FLAT HINGE<br/>x 12' Mill Finish 6 pcs<br/>41-63-824N Shutter Mount<br/>Mates with 41-63-816, 41-63-813, 41-63-811, 41-63-824N</p>   |
| <p>1" SLIP COLLAR<br/>Mill Order Mill Finish<br/>(Call for Price)</p>    | <p>.875 SERRATED TUBE<br/>x 20'<br/>Mill Finish 26 pcs<br/>52-63-537</p>   | <p>1.0 SERRATED TUBE<br/>x 20'<br/>Mill Finish 32 pcs<br/>51-63-381</p>   | <p>STORM BAR x 24'<br/>20-63-225 1 x 2 x 1/8<br/>Mill Finish<br/>20-COLOR-231 1 x 2 x 1/8<br/>Painted<br/>20-63-689 1 x 3 x 1/8<br/>Mill Finish<br/>20-COLOR-230 1 x 3 x 1/8<br/>Painted</p>  |
| <p>HV™ COLONIAL WOOD<br/>DOUBLE HINGE<br/>41-63-843 Mill Finish<br/>Wall Mount<br/>Mates with 41-63-845<br/>100 pcs/box</p>                 | <p>HV™ COLONIAL CON-<br/>CRETE DOUBLE HINGE<br/>41-63-844 Mill Finish<br/>Wall Mount<br/>Mates with 41-63-845<br/>100 pcs/box</p>    | <p>HV™ COLONIAL<br/>FLAT HINGE<br/>41-63-845 Mill Finish<br/>Shutter Mount, Mates with 41-63-843, 41-63-844, 41-63-847, 41-63-848, 41-63-845 100 pcs/box</p>                    | <p>HV™ COLONIAL<br/>STORM BAR CLIP<br/>41-63-840 Mill Finish<br/>Shutter/Jamb Mount<br/>250 pcs/box</p>    |
| <p>HV™ COLONIAL/B&amp;B CON-<br/>CRETE SINGLE HINGE<br/>41-63-847 6063 T6 M/F<br/>Wall Mount<br/>Mates with 41-63-845<br/>100 pcs/box</p>  | <p>HV™ COLONIAL/B&amp;B WOOD<br/>SINGLE HINGE<br/>41-63-848 6063 T6 M/F<br/>Wall Mount<br/>Mates with 41-63-845<br/>100 pcs/box</p>  | <p>HV™ BAHAMA WOOD<br/>STORM CLIP<br/>41-63-841 Mill Finish<br/>Wall Mount<br/>100 pcs/box (50-L, 50-R)</p>  <p><i>May use other commercially available mounting clips.</i></p> | <p>HV™ BAHAMA<br/>CONCRETE STORM CLIP<br/>41-63-842 Mill Finish<br/>Wall Mount 100 pcs/box</p>  <p><i>May use other commercially available mounting clips.</i></p>                           |



**Eastern Metal Supply**  
Quality Shapes In Aluminum

EMS FL

1-800-432-2204

(561) 588-4780 - fax

EMS NC

1-800-343-8154

(704) 391-2267 - fax

EMS TX

1-800-996-6061

(281) 656-2297 - fax

EMS MO

1-888-822-6061

(314) 344-3349 - fax

**Additional Locations:** West Palm Beach & Lakeland, FL and Newark, DE

**website:** [www.easternmetal.com](http://www.easternmetal.com)

**e-mail:** [info@easternmetal.com](mailto:info@easternmetal.com)

Low\_Profile-10/02/09

# Eastern Metal Supply

**NEW FOR  
MARCH 2009!**

## HV Low Profile **Decorative Bahama** Colonial System

### HV Low Profile Z-Blade System Schematic

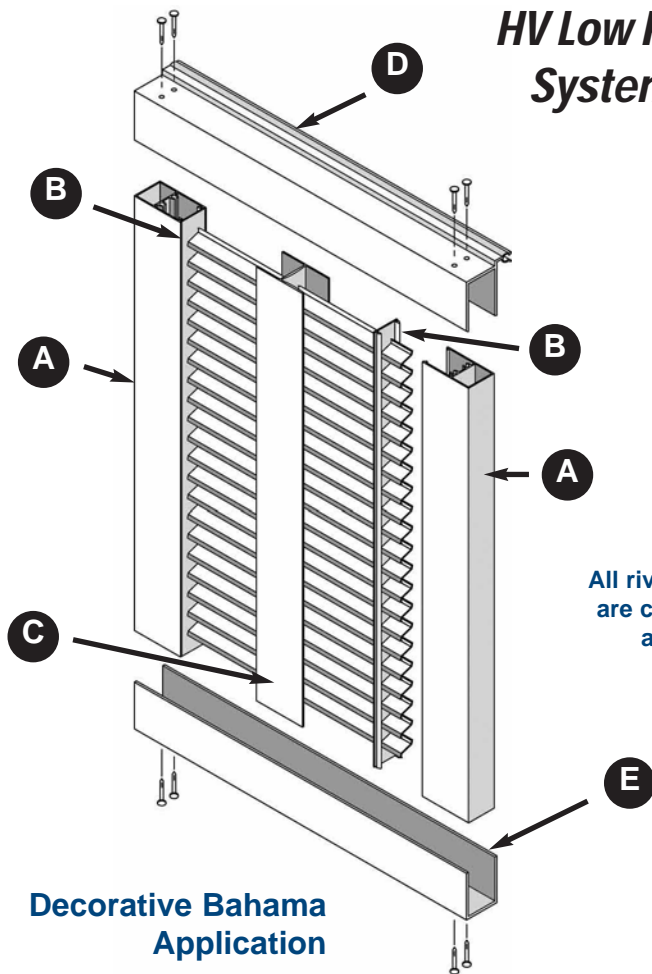

**Decorative Bahama Application**

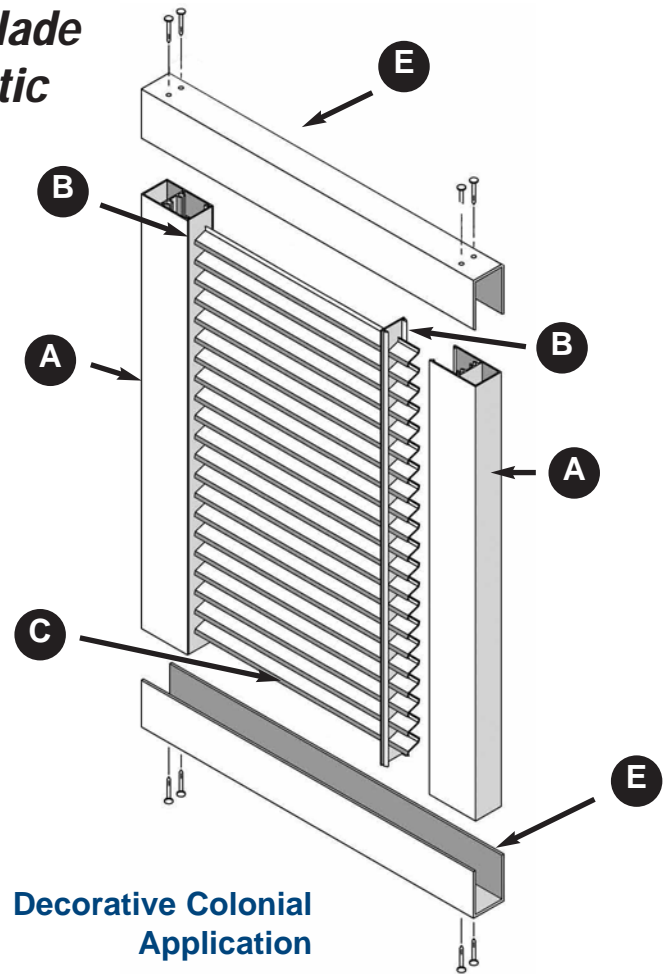

**Decorative Colonial Application**

All rivets & screws are commercially available.

**Note: For applications requiring code rated hurricane protection refer to EMS High Visibility Bahama/Colonial product.**

|  |  |   |  |   |
|--|--|---|--|---|
| <p>HV LOW PROFILE VERTICAL FRAME WITH SNAP x 16' 2" for Z-Blade System<br/>Mates with 41-63-861R/L<br/>41-63-860 Mill Finish</p> | <p>HV LOW PROFILE Z - SNAP PLATE x 16' 2" for Z-Blade System<br/>Mates with 41-63-860<br/>Punched to accept Z-Blade<br/>41-63-861R Right MF<br/>41-63-861L Left MF</p> | <p>HV LOW PROFILE BAHAMA PUNCHED CENTER MULLION<br/>41-63-838PZ (Z-blade)<br/>Used for wider spans.<br/>Mill Finish<br/>Bahama Applications</p> | <p>HV LOW PROFILE BAHAMA FRAME w/HINGE x 12'<br/>41-63-837 Mill Finish<br/>NOT PRE-PUNCHED</p> | <p>HV LOW PROFILE TOP &amp; BOTTOM FRAME x 12'<br/>41-63-833 Mill Finish<br/>NOT PRE-PUNCHED<br/>Also used as an intermediate rail in Colonials</p> |
|  |  |   |  |   |

Currently available for decorative applications; Future code testing pending



**Eastern Metal Supply**  
Quality Shapes In Aluminum

[EMS FL](#)

1-800-432-2204  
(561) 588-4780 - fax

[EMS NC](#)

1-800-343-8154  
(704) 391-2267 - fax

[EMS TX](#)

1-800-996-6061  
(281) 656-2297 - fax

[EMS MO](#)

1-888-822-6061  
(314) 344-3349 - fax

**Additional Locations:** West Palm Beach & Lakeland, FL and Newark, DE

**website:** [www.easternmetal.com](http://www.easternmetal.com)

**e-mail:** [info@easternmetal.com](mailto:info@easternmetal.com)

Low\_Profile-10/02/09