

Engineered Window Mullion and Clip Extrusions

Our mullions can be used with any Approved Fenestration Product, under separate approval.
 Florida Building Code Approved by Engineering - Tube Mulls: FL17472.2 • Bay/Bow Mulls: FL17472.1

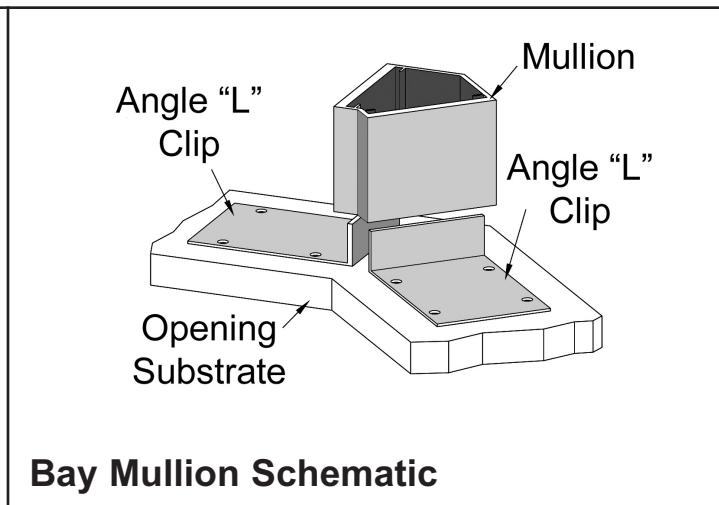
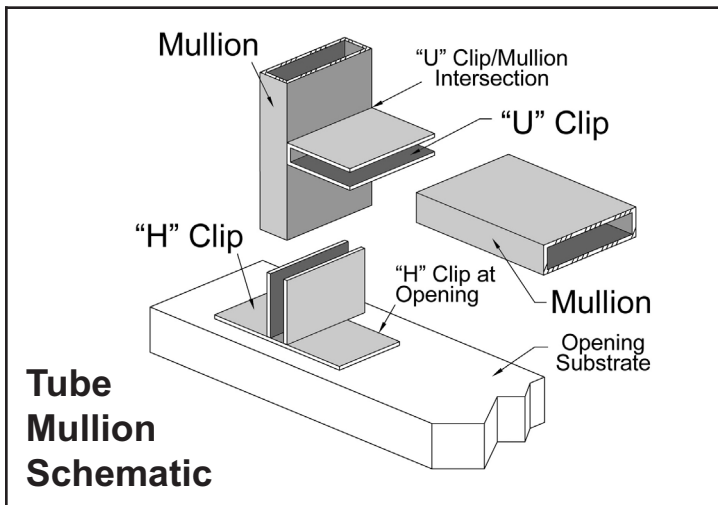

1 x 3-1/8 Light Mullion x 24'
 Wall: 1/8" & 3/8"
54314-MBP-1 Bronze
54314-WHP-1 White
54314-DS-1 Desert Sand

1 x 3-1/8 Heavy Mullion x 24'
 Wall: 1/8" & 5/8"
54315-MBP-1 Bronze
54315-WHP-1 White

1-1/4 x 3 Mullion x 24'
 Wall: .281"
56371-MBP-1 Bronze
56371-WHP-1 White

1 x 4 Mullion x 24'
 Wall: 1/4"
610236-MBP-1 Bronze
610236-WHP-1 White

2 x 4 Mullion x 24'
 Wall: 1/4"
35097-MBP-1 Bronze
35097-WHP-1 White

2 x 6 Mullion x 24'
 Wall: 1/4"
610068-MBP-1 Bronze
610068-WHP-1 White

Additional Mullions and Clips available next page

Standards 37



Eastern Metal Supply
 Quality Shapes In Aluminum

EMS FL
 1-800-432-2204
 (561) 588-4780 - fax

EMS NC
 1-800-343-8154
 (704) 391-2267 - fax

EMS TX
 1-800-996-6061
 (281) 656-2297 - fax

EMS MO
 1-888-822-6061
 (314) 344-3349 - fax

Additional Locations: West Palm Beach & Lakeland, FL; Newark, DE; Akron, OH, Van Buren, AR; Atlanta, GA and Dallas, TX
website: www.EasternMetal.com **e-mail:** info@EasternMetal.com **version:** 03/26/19

Engineered Window Mullion and Clip Extrusions

Our mullions can be used with any Approved Fenestration Product, under separate approval.
 Florida Building Code Approved by Engineering - Tube Mulls: FL17472.2 • Bay/Bow Mulls: FL17472.1

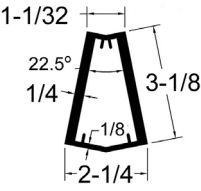
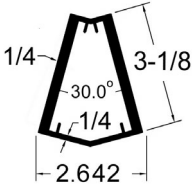
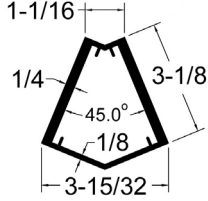
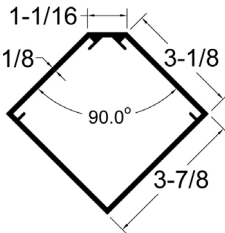
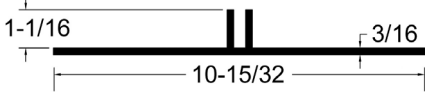
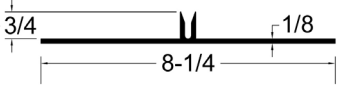
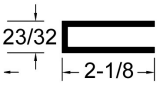
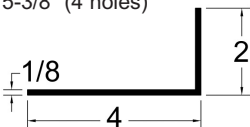
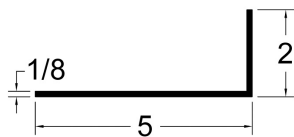
<p>22.5° Mullion x 24' 54306-MBP-1 Bronze 54306-WHP-1 White</p> 	<p>30° Mullion x 24' 59701-MBP-1 Bronze 59701-WHP-1 White</p> 	<p>45° Mullion x 24' 54308-MBP-1 Bronze 54308-WHP-1 White</p> 
<p>90° Mullion x 24' 54307-MBP-1 Bronze 54307-WHP-1 White</p> 	<p>1 x 3-1/8 Mullion Clip x 12' 54316-63-1 Mill Finish <i>Mates with 1 x 3-1/8 Mullions</i></p> <p>Fabbed for 1 x 3-1/8 Light Mullion 80000 x 2-1/4" (6 holes) Fabbed for 1 x 3-1/8 Heavy Mullion 80001 x 1-3/4" (6 holes)</p> 	<p>1 x 4 Mullion Clip x 12' 54442-63-1 Mill Finish <i>Mates with 1 x 4 Mullion</i></p> <p>Fabbed for 1 x 4 Mullion 80009 x 3-3/8" (8 holes)</p> 
<p>1 x 3-1/8 Mullion U-Clip x 12' 52-63-11886 Mill Finish <i>Mates with 1 x 3-1/8 Mullions</i></p> <p>Fabbed for 1 x 3-1/8 Light Mullion 80008 x 2-1/4" (3 holes) Fabbed for 1 x 3-1/8 Heavy Mullion 80007 x 1-3/4" (3 holes)</p> 	<p>2 x 4 x 1/8 Angle L-Clip x 20' 11-63-395 Mill Finish <i>Mates with 2 x 4 Mullion</i></p> <p>Fabbed for 22.5° Mullion; 45° Mullion; 90° Mullion 80006 x 2-3/4" (4 holes) Fabbed for 1 x 4 Mullion; 2 x 4 Mullion 80004 x 3-3/8" (4 holes) Fabbed for 2 x 6 Mullion 80005 x 5-3/8" (4 holes)</p> 	<p>2 x 5 x 1/8 Angle L-Clip x 20' 11-63-405 Mill Finish <i>Mates with 2 x 5 Mullion</i></p> <p>Fabbed for 1 x 3-1/8 Light Mullion 80002 x 2-1/4" (3 holes) Fabbed for 1 x 3-1/8 Heavy Mullion 80003 x 1-3/4" (3 holes) Fabbed for 1-1/4 x 3 Heavy Mullion 80011 x 7/8" (3 holes)</p> 

Non-Engineered Window Mullion and Clip Extrusions

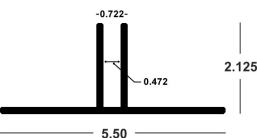
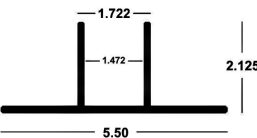
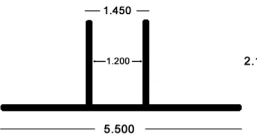
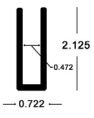
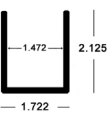
<p>1" Clip x 12' 52-63-8745 <i>Inserts into 20-WH/MB-2320 and 20-WH/MB-2350</i></p> 	<p>2" Clip x 12' 52-63-8746 <i>Inserts into 2" Rect Tube (.125 Wall)</i></p> 	<p>2" Clip x 12' 52-63-11885 <i>Inserts into a 2" Rect Tube (.250 wall)</i></p> 	<p>1" Inside U-Clip x 12' 52-63-11886 <i>Inserts into 1" Rect Tube (.125 Wall)</i></p>  <p>2" Inside U-Clip x 12' 52-63-11887 <i>Inserts into 2" Rect Tube (.125 Wall)</i></p> 	<p>1 x 2-3/4 Mullion Bars x 24' Wall: .375/.125 20-MB-2320 Bronze 20-WH-2320 White</p> <p>1 x 4 Mullion Bars x 24' Wall: .375/.125 20-MB-2350 Bronze 20-WH-2350 White</p> <p>Additional Painted Bars on Standards p36</p>
<p>Standards 38</p>				



EMS FL	EMS NC	EMS TX	EMS MO
1-800-432-2204 (561) 588-4780 - fax	1-800-343-8154 (704) 391-2267 - fax	1-800-996-6061 (281) 656-2297 - fax	1-888-822-6061 (314) 344-3349 - fax

Eastern Metal Supply Additional Locations: West Palm Beach & Lakeland, FL; Newark, DE; Akron, OH, Van Buren, AR; Atlanta, GA and Dallas, TX
 Quality Shapes In Aluminum website: www.EasternMetal.com e-mail: info@EasternMetal.com version: 07/17/19